

## Copriterminali isolanti in nylon

- RESISTENTI AGLI SBALZI DI TEMPERATURA, AGLI OLII, BENZINE ECC.
- RISPONDENTI ALLE CARATTERISTICHE PREVISTE DAI MAGGIORI CAPITOLATI

CODICE	DESCRIZIONE	RIF. ORIGINALE	PER TERMINALI FEMMINA	PASSO
317 00 02910	1411	FIAT 1/23331/87	317 00 02900 - 1410	2,8

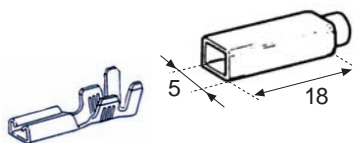

CODICE	DESCRIZIONE	RIF. ORIGINALE	PER TERMINALI FEMMINA	PASSO
317 00 07310	18639	-	317 00 07300 - 18638	4,7

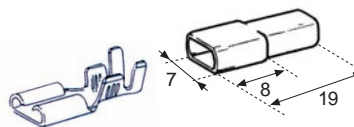

CODICE	DESCRIZIONE	RIF. ORIGINALE	PER TERMINALI FEMMINA	PASSO
317 00 04620	1440	-	317 00 02550 - 1402	6,3

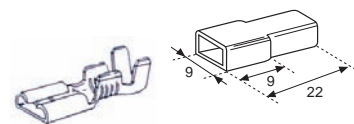

- RESISTENTI AGLI SBALZI DI TEMPERATURA, AGLI OLII, BENZINE ECC.
- RISPONDENTI ALLE CARATTERISTICHE PREVISTE DAI MAGGIORI CAPITOLATI

CODICE	DESCR.	RIF. ORIGINALE	PER TERMINALI MASCHIO + FEMMINA	PASSO
317 00 00400	1005	FIAT 1/20610/8	317 00 02600 - 1403 317 00 002610 - 1403/B 317 00 04600 - 1439 317 00 04610 - 1439/B	6,3

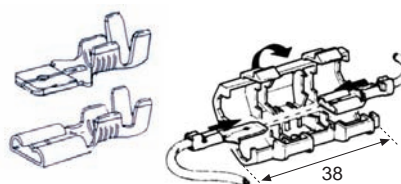

CODICE	DESCRIZIONE	COLORE	PER TERMINALI FEMMINA	PASSO
317 00 00600	1008	NERO	317 00 02600 - 1403 317 00 02610 - 1403/B	6,3
317 00 00604	1008/BL	BLU		
317 00 04400	1430	ROSSO		

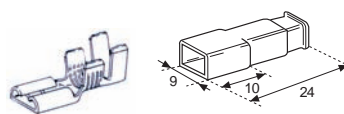

CODICE	DESCRIZIONE	COLORE	PER TERMINALI MASCHIO	PASSO
317 00 04500	1431	NERO	317 00 04600 - 1439 317 00 04610 - 1409/B	6,3
317 00 02505	1400/BL	BLU		
317 00 02500	1400	ROSSO		

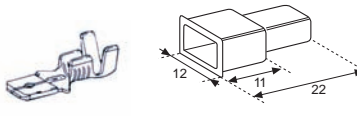

CODICE	DESCRIZIONE	RIF. ORIGINALE	PER TERMINALI FEMMINA	PASSO
317 00 21660	52355	FIAT 1/23387/87	317 00 21625 - 52348	6,3

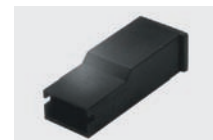
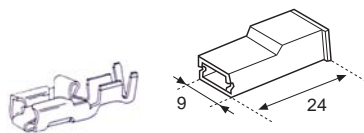

CODICE	DESCRIZIONE	RIF. ORIGINALE	PER TERMINALI FEMMINA	PASSO
317 00 05105	1447	FIAT 1/23371/87	317 00 25700 - 52700	6,3

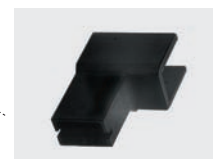
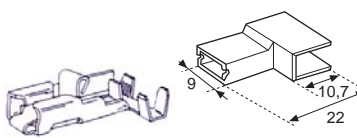

CODICE	DESCRIZIONE	RIF. ORIGINALE	PER TERMINALI FEMMINA	PASSO
317 00 21640	52351	FIAT 1/23335/80	317 00 07300 - 18638	4,7

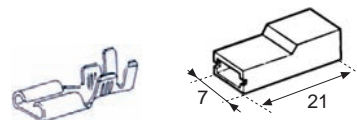

5

Realizzazione: Ufficio Pubblicità Interno della Meccanocar c/ Meccanocar s.r.l. a norma della legge sul diritto d'autore. È vietata la riproduzione anche parziale con qualsiasi metodo: elettronico, meccanico, in fotocopia, o altro. La MECCANOCAR s.r.l. si riserva il diritto di apportare senza preavviso tutte le modifiche che si rendano necessarie.

## Copriterminali isolanti in nylon

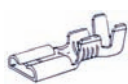
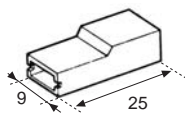
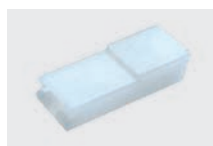

CODICE	DESCRIZIONE	RIF. ORIGINALE	PER TERMINALI FEMMINA	PASSO
<b>317 00 21645</b>	<b>52352</b>	FIAT 1/20558/80	317 00 02600 - 1403 317 00 02610 - 1403/B	6,3

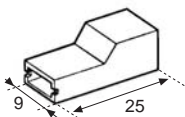
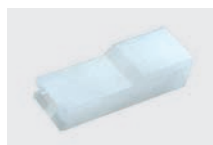

CODICE	DESCRIZIONE	RIF. ORIGINALE	PER TERMINALI FEMMINA	PASSO
<b>317 00 21650</b>	<b>52353</b>	FIAT 1/20559/80	317 00 02550 - 1402	6,3

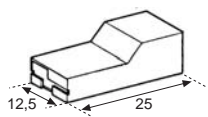
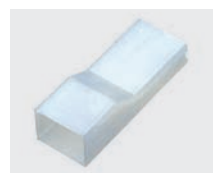

- RESISTENTI AGLI SBALZI DI TEMPERATURA, AGLI OLII, BENZINE ECC.
- RISPONDENTI ALLE CARATTERISTICHE PREVISTE DAI MAGGIORI CAPITOLATI

CODICE	DESCR.	RIF. ORIGINALE	PER TERMINALI FEMMINA	PASSO
<b>317 00 21655</b>	<b>52354</b>	FIAT 1/20557/85	317 00 03900 - 1423	9,5

**5**

## Blocchetti porta femmine a 3 vie per lampade H4

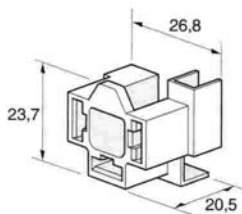

- BLOCCHETTO PORTA TERMINALI PER LAMPADE CON ATTACCO ASIMMETRICO + H4
- COLORE BIANCO

CODICE	DESCRIZIONE	RIF. ORIGINALE	PER TERMINALI FEMMINA	PASSO
<b>317 00 21085</b>	<b>52242</b>	FIAT 1/02579/80	317 00 21320 - 52289	7,7

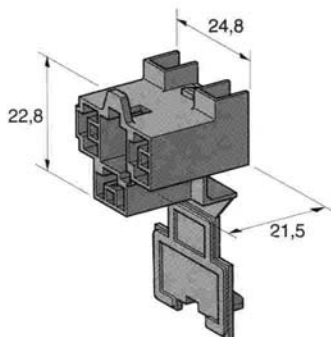

- CON SPORTELLINO ISPEZIONE
- COLORE NERO

CODICE	DESCRIZIONE	TERMINALE A BANDIERA INSERIBILE	PASSO
<b>317 00 25720</b>	<b>52702</b>	317 00 25730-52703	7,7

## Blocchetto porta femmine a 2 vie per lampade H7



CODICE	DESCRIZIONE	TERMINALE ANTIFILAMENTO INSERIBILE	PASSO
<b>317 00 25710</b>	<b>52701</b>	317 00 25700-52700	6,3

# Connettori per terminali maschio e femmina con dentino di ritegno passo 6,3

TERMINALI INSTALLABILI SU TUTTI I CONNETTORI



MASCHIO, C/DENTE PASSO 6.3

CODICE	DESCR.	SEZ. CAVO mm <sup>2</sup>	MATERIALE
<b>317 00 02960</b>	<b>1412/1</b>	0.3 - 0.8	OTTONE GREZZO
<b>317 00 03000</b>	<b>1413</b>	1 - 2.5	OTTONE GREZZO
<b>317 00 03010</b>	<b>1413/B</b>	1 - 2.5	OTTONE STAGNATO
<b>317 00 02950</b>	<b>1412</b>	4 - 6	OTTONE STAGNATO



FEMMINA, C/DENTE PASSO 6.3

CODICE	DESCR.	SEZ. CAVO mm <sup>2</sup>	MATERIALE
<b>317 00 02700</b>	<b>1404</b>	1 - 2.5	OTTONE GREZZO
<b>317 00 02710</b>	<b>1404/B</b>	1 - 2.5	OTTONE STAGNATO
<b>317 00 02720</b>	<b>1405</b>	4 - 6	OTTONE STAGNATO



1 VIA MASCHIO

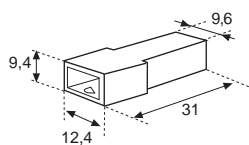

CODICE	DESCR.	RIF. ORIGINALE
<b>317 00 00700</b>	<b>1015</b>	FIAT I 20589 80



1 VIA FEMMINA

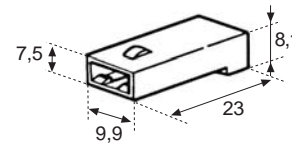

CODICE	DESCR.	RIF. ORIGINALE
<b>317 00 00800</b>	<b>1016</b>	FIAT I 20590 80



2 VIE MASCHIO

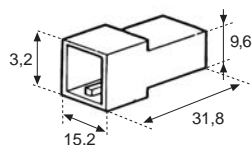

CODICE	DESCR.	RIF. ORIGINALE
<b>317 00 00900</b>	<b>1017</b>	FIAT I 20605 80



2 VIE FEMMINA

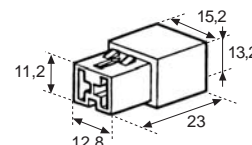

CODICE	DESCR.	RIF. ORIGINALE
<b>317 00 01000</b>	<b>1018</b>	FIAT I 20604 80



2 VIE A "T" MASCHIO

MASCHIO

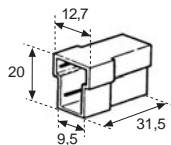

CODICE	DESCR.	RIF. ORIGINALE
<b>317 00 01100</b>	<b>1019</b>	FIAT I 20599 80



2 VIE A "T" FEMMINA

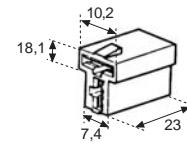

CODICE	DESCR.	RIF. ORIGINALE
<b>317 00 01200</b>	<b>1020</b>	FIAT I 20598 80



3 VIE MASCHIO

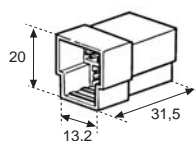

CODICE	DESCR.	RIF. ORIGINALE
<b>317 00 01300</b>	<b>1021</b>	FIAT I 20668 80



3 VIE FEMMINA

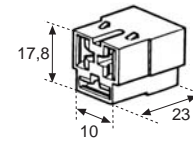

CODICE	DESCR.	RIF. ORIGINALE
<b>317 00 01400</b>	<b>1022</b>	FIAT I 20667 80

Realizzazione: Ufficio Pubblicità Interno della Meccanocar - c/MECCANOCAR s.r.l. a norma della legge sul diritto d'autore. È vietata la riproduzione anche parziale con qualsiasi metodo: elettronico, meccanico, in fotocopia, o altro. La MECCANOCAR s.r.l. si riserva il diritto di approntare senza preavviso tutte le modifiche che si rendono necessarie.

5

# Connettori per terminali maschio e femmina con dente di ritenimento passo 6,3

**5**

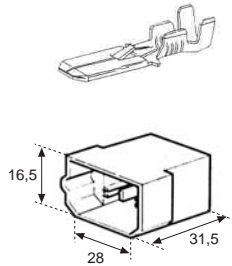

4 VIE MASCHIO



CODICE	DESCR. ORIGINALE	RIF.
317 00 01500	1023	FIAT I 20581 80

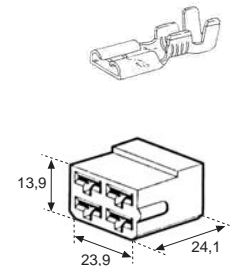

4 VIE FEMMINA



CODICE	DESCR. ORIGINALE	RIF.
317 00 01600	1024	FIAT I 20580 80



6 VIE MASCHIO

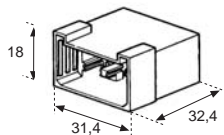

CODICE	DESCR. ORIGINALE	RIF.
317 00 01700	1025	FIAT I 02504 80



6 VIE FEMMINA

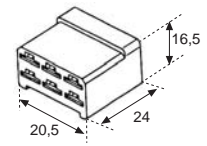

CODICE	DESCR. ORIGINALE	RIF.
317 00 02400	1033	-



6 VIE FEMMINA CON ALETTE

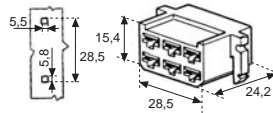

CODICE	DESCR. ORIGINALE	RIF.
317 00 01800	1026	FIAT I 02503 80



6 VIE MASCHIO CON ALETTE

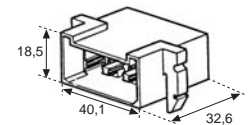

CODICE	DESCR. ORIGINALE	RIF.
317 00 01900	1027	FIAT I 20611 80



8 VIE FEMMINA

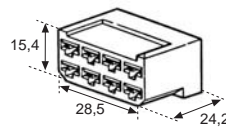

CODICE	DESCR. ORIGINALE	RIF.
317 00 02000	1028	FIAT I 20606 80



8 VIE MASCHIO

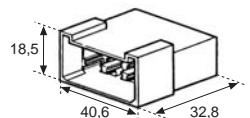

CODICE	DESCR. ORIGINALE	RIF.
317 00 02100	1029	FIAT I 20607 80



11 VIE MASCHIO

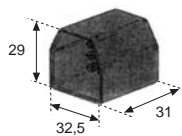

CODICE	DESCR. ORIGINALE	RIF.
317 00 00630	1012	FIAT I 20625 87



11 VIE FEMMINA

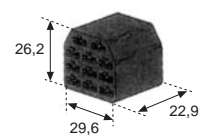

CODICE	DESCR. ORIGINALE	RIF.
317 00 00650	1013	FIAT I 20624 87

Realizzazione: Ufficio Pubblicità Interno della Meccanocar - © MECCANOCAR s.r.l. a norma della legge sul diritto d'autore, è vietata la riproduzione anche parziale con qualsiasi metodo: elettronico, meccanico, fotografico, o altro. La MECCANOCAR s.r.l. si riserva il diritto di apportare senza preavviso tutte le modifiche che si rendano necessarie.

## BLOCCHETTI PORTA FEMMINA E PORTA MASCHIO MISTO A 2 VIE



### Blocchetto porta femmine

- APPLICAZIONE: AUTOARRI IVECO

CODICE	DESCR.	N° VIE
317 00 25780	52708	2

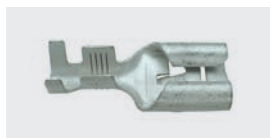

### Terminali inseribili femmina



CODICE	DESCR.	PASSO
317 00 02700	1404	6,3
317 00 03810	1422	9,5

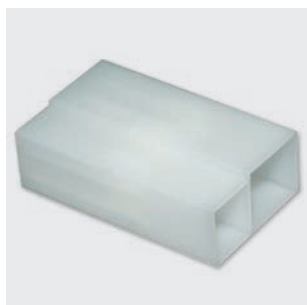

### Blocchetto porta maschi

CODICE	DESCR.	N° VIE
317 00 25790	52709	2



### Terminali inseribili maschio



CODICE	DESCR.	PASSO
317 00 03000	1413	6,3
317 00 03820	1422/1	9,5

## BLOCCHETTI FEMMINA E MASCHIO PER TERMINALI A SPINA

### Blocchetti porta femmine



- SERIE MATE-N-LOCK
- PER APPLICAZIONI VARIE

CODICE	DESCR.	N° VIE
317 00 25800	52710	1
317 00 25810	52711	2
317 00 25820	52712	3
317 00 25830	52713	4
317 00 25840	52714	6
317 00 25850	52715	9
317 00 25860	52716	12
317 00 25870	52717	15



### Terminale inseribili femmina

CODICE	DESCR.	SEZ.CAVO
317 00 21790	52381	0,5-2,0

### Blocchetti maschio serie mate-n-lock



- SERIE MATE-N-LOCK
- PER APPLICAZIONI VARIE

CODICE	DESCR.	N° VIE
317 00 25890	52719	1
317 00 25900	52720	2
317 00 25910	52721	3
317 00 25920	52722	4
317 00 25930	52723	6
317 00 25940	52724	9
317 00 25950	52725	12
317 00 25960	52726	15



### Terminale inseribile maschio

CODICE	DESCR.	SEZ.CAVO
317 00 21785	52380	0,5-2,0

Realizzazione: Ufficio Pubblicità Interno della Meccanocar - c/MECCANOCAR s.r.l. a norma della legge sul diritto d'autore, è vietata la riproduzione anche parziale con qualsiasi metodo: elettronico, meccanico, in fotocopia, o altro. La MECCANOCAR s.r.l. si riserva il diritto di apportare senza preavviso tutte le modifiche che si rendano necessarie.

5



## Connettore porta femmine serie timer



- PER AUTORADIO E NAVIGATORE
- PER RIPRISTINO VETTURA IN CASO DI FURTO AUTORADIO

CODICE	DESCR.	N° VIE	COLORE
317 00 26040	52734N	8	NERO
317 00 26050	52735B	8	BIANCO

## CONNETTORI PORTA FEMMINA SERIE SIGMA II

5



### Connettori porta femmina

- APPLICAZIONE: SENSORI MOTORE

CODICE	DESCR.	N° VIE
317 00 26130	52743	2
317 00 26140	52744	3
317 00 26150	52745	4



### Terminale femmina serie sigma II

CODICE	DESCR.	SEZ.CAVO
317 00 22595	52541	0,35-0,75

## CONNETTORI A TENUTA STAGNA "SUPERSEAL" CON SECONDARY LOCK PER TERMINALI PASSO 1,5

### Connettori porta maschio "superseal"



2 VIE MASCHIO

- APPLICAZIONI: SENSORI VANO MOTORE

CODICE	DESCR.	N° VIE
317 00 21440	52311	1
317 00 21450	52313	2
317 00 21465	52316	3
317 00 21475	52318	4
317 00 21485	52320	5
317 00 22420	52506	6

### Terminale maschio passo 1,5 inseribile



CODICE	DESCR.	SEZ.CAVO
317 00 22375	52497	1,0-1,5

### Tappo per fori non utilizzati per connettori maschio e femmina



CODICE	DESCR.	MATERIALE
317 00 22410	52504	SILICONE

### Gommino di tenuta per terminali maschio e femmina



CODICE	DESCR.	MATERIALE
317 00 21415	52306	SILICONE

### Connettori porta femmine "superseal"



2 VIE FEMMINA

CODICE	DESCR.	N° VIE
317 00 21435	52310	1
317 00 21445	52312	2
317 00 21455	52314	3
317 00 21470	52317	4
317 00 21480	52319	5
317 00 22415	52505	6

### Terminale femmina passo 1,5 inseribile



CODICE	DESCR.	SEZ.CAVO
317 00 22370	52496	1,0-1,5

## CONNETTORI A TENUTA STAGNA "SERIE 280"



2 VIE MASCHIO

### Connettori porta maschio "serie 280"

- APPLICAZIONI:  
VANO MOTORE

CODICE	DESCR.	N° VIE
317 00 21495	52322	1
317 00 21505	52324	2
317 00 21515	52326	3



### Terminale maschio "serie 280" inseribile

CODICE	DESCR.	SEZ.CAVO
317 00 21425	52308	1,0-2,5

### Gommino di tenuta per terminali maschio e femmina



CODICE	DESCR.	MATERIALE
317 00 21430	52309	SILICONE

### Connettori porta femmina "serie 280"



2 VIE FEMMINA

CODICE	DESCR.	N° VIE
317 00 21490	52321	1
317 00 21500	52323	2
317 00 21510	52325	3

### Connettore circolare porta femmine "serie 280"



- APPLICAZIONI:  
VANO MOTORE, BULBO  
VENTOLA OPEL/FIAT

CODICE	DESCR.	N° VIE
317 00 26160	52746	3

### Terminale femmina "serie 280"



CODICE	DESCR.	SEZ.CAVO
317 00 21420	52307	1,0-1,5

## CONNETTORI ECONOSEAL A TENUTA STAGNA PER IVECO



### Connettore porta maschio "econoseal"

- APPLICAZIONI:  
SENSORI

CODICE	DESCR.	N° VIE
317 00 15795	52121	2

### Terminale maschio "econoseal" inseribile



CODICE	DESCR.	SEZ.CAVO
317 00 21795	52382	0,5-1,5

### Connettore porta femmine "econoseal"



CODICE	DESCR.	N° VIE
317 00 15796	52122	2

### Terminale femmina "econoseal" inseribile



CODICE	DESCR.	SEZ.CAVO
317 00 21800	52383	0,5-1,5

Realizzazione: Ufficio Pubblicità Interno della Meccanocar - c/MECCANOCAR s.r.l. a norma della legge sul diritto d'autore. È vietata la riproduzione anche parziale con qualsiasi metodo: elettronico, meccanico, in fotocopia, o altro. La MECCANOCAR s.r.l. si riserva il diritto di apportare senza preavviso tutte le modifiche che si rendano necessarie.

5

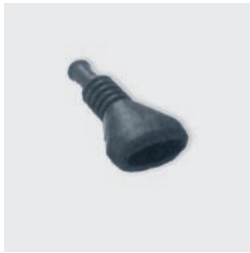

## Cappuccio 2 vie

CODICE	DESCR.	N° VIE
317 00 22035	52430	2



- APPLICAZIONI:  
INIEZIONE ELETTRONICA,  
PER SENSORI ED INIETTORI

## Connettori porta femmina junior timer

CODICE	DESCR.	N° VIE
317 00 22310	52484	2
317 00 22330	52488	3
317 00 22335	52489	4
317 00 22340	52490	5
317 00 22345	52491	6
317 00 22350	52492	7

## Terminale femmina "junior timer" inseribili



CODICE	DESCR.	SEZ.CAVO
317 00 22300	52482	0,5-1,5



CODICE	DESCR.	COLORE
317 00 22305	52483	BLU

## Connettore porta maschio "power timer"



CODICE	DESCR.	N° VIE
317 00 22355	52493	2

## Terminale maschio "power timer" inseribile



CODICE	DESCR.	SEZ.CAVO
317 00 22360	52494	0,5-1,0

## Connettore porta maschio "junior power timer"

- APPLICAZIONE:  
PER SENSORI E  
INIETTORI

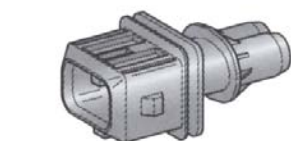

CODICE	DESCR.	N° VIE
317 00 25770	52707	2

## Terminale maschio jpt inseribile



CODICE	DESCR.	SEZ.CAVO
317 00 25740	52704	0,5-1,0



CODICE	DESCR.	COLORE
317 00 25760	52706	CELESTE

## Gommino di tenuta per terminali jpt